

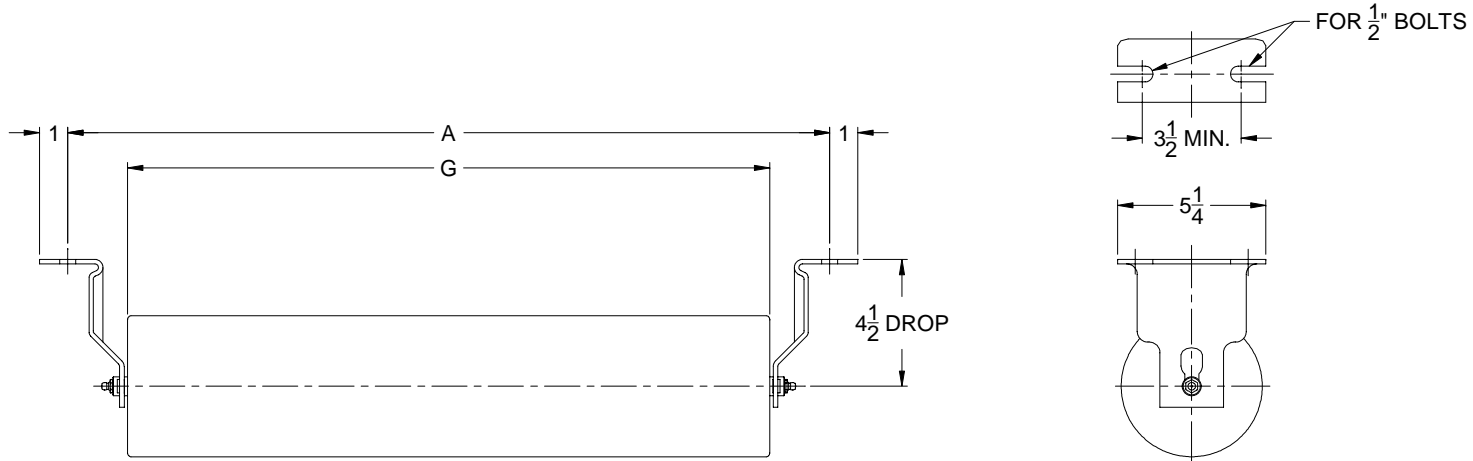

STEPHENS-ADAMSON CONVEYING

Note: Dimensions for REFERENCE ONLY and are SUBJECT TO CHANGE WITHOUT NOTICE.
Contact Stephens-Adamson Conveying for Certified Dimensions Prints.

CEMA "B" 2170 Series 4-1/2" Drop Return Idlers - Regreasable



'Dimensions in Inches'

Belt Width	Roller Assembly Part Number	2174- 4-1/2" Return Idler Dimensions 4" dia. Rolls		Assembly Weight
		A	G	
18"	214-18-91-0200	27	22-3/4	16 lbs.
20"	214-20-91-0200	29	24-3/4	17 lbs.
24"	214-24-91-0200	33	28-3/4	19 lbs.
30"	214-30-91-0200	39	34-3/4	22 lbs.
36"	214-36-91-0200	45	40-3/4	25 lbs.
42"	214-42-91-0200	51	46-3/4	29 lbs.
48"	214-48-91-0200	57	52-3/4	32 lbs.

Belt Width	Roller Assembly Part Number	2175- 4-1/2" Return Idler Dimensions 5" dia. Rolls		Assembly Weight
		A	G	
18"	215-18-91-0200	27	22-3/4	19 lbs.
20"	215-20-91-0200	29	24-3/4	20 lbs.
24"	215-24-91-0200	33	28-3/4	23 lbs.
30"	215-30-91-0200	39	34-3/4	26 lbs.
36"	215-36-91-0200	45	40-3/4	30 lbs.
42"	215-42-91-0200	51	46-3/4	34 lbs.
48"	215-48-91-0200	57	52-3/4	38 lbs.

4-1/2" Drop Bracket
Part Number

MD-IDL19-57-00

Note: BRACKETS ARE PRICED AND SOLD SEPARATELY, TWO BRACKETS ARE REQUIRED PER ROLLER.

STEPHENS-ADAMSON CONVEYING

www.Stephens-Adamson.com

CANADA
Telephone: 1-800-510-3802
Fax: 1-613-967-8128

U.S.A.
Telephone: 1-800-638-6788
Fax: 1-800-866-1438

INTERNATIONAL
Telephone: 1-613-962-3411
Fax: 1-613-967-8128

DS-E-IDL-00-050



STEPHENS-ADAMSON CONVEYING

Note: Dimensions for REFERENCE ONLY and are SUBJECT TO CHANGE WITHOUT NOTICE.
Contact Stephens-Adamson Conveying for Certified Dimensions Prints.

CEMA "B" 2170 Series 114 mm Drop Return Idlers - Regreasable

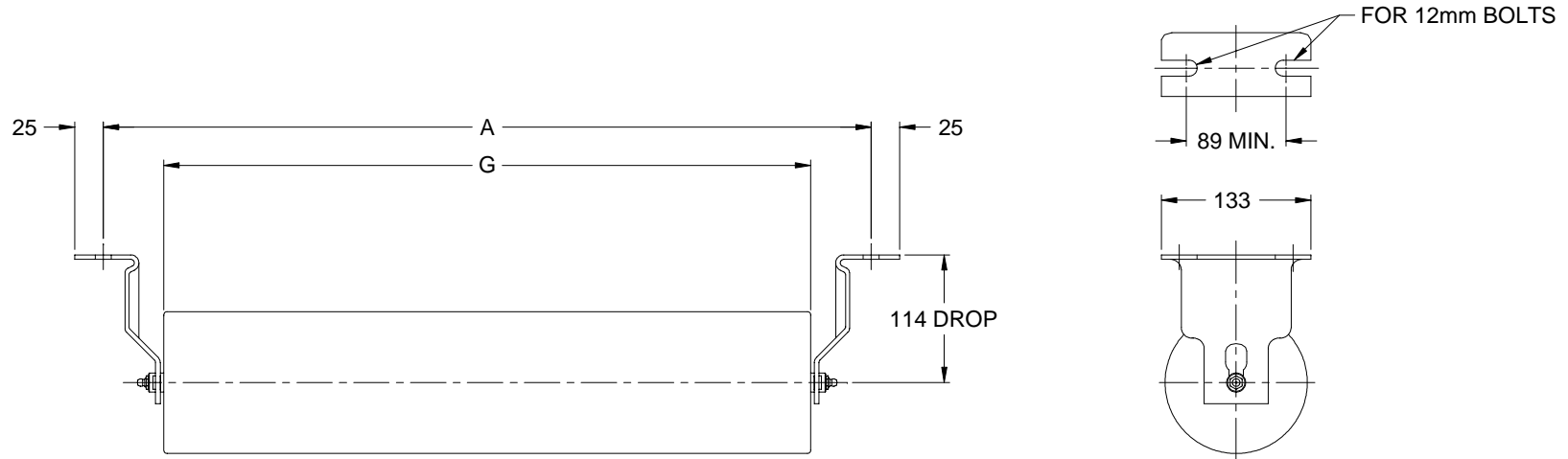

'Dimensions in Millimeters'

Belt Width	Roller Assembly Part Number	2174- 114 mm Return Idler Dimensions 102 mm dia. Rolls		Assembly Weight
		A	G	
457 mm	214-18-91-0200	686	578	7 kg.
508 mm	214-20-91-0200	737	629	8 kg.
610 mm	214-24-91-0200	838	730	9 kg.
762 mm	214-30-91-0200	991	883	10 kg.
914 mm	214-36-91-0200	1143	1035	11 kg.
1067 mm	214-42-91-0200	1295	1187	13 kg.
1219 mm	214-48-91-0200	1448	1340	15 kg.

Belt Width	Roller Assembly Part Number	2175- 114 mm Return Idler Dimensions 127 mm dia. Rolls		Assembly Weight
		A	G	
457 mm	215-18-91-0200	686	578	9 kg.
508 mm	215-20-91-0200	737	629	9 kg.
610 mm	215-24-91-0200	838	730	10 kg.
762 mm	215-30-91-0200	991	883	12 kg.
914 mm	215-36-91-0200	1143	1035	14 kg.
1067 mm	215-42-91-0200	1295	1187	15 kg.
1219 mm	215-48-91-0200	1448	1340	17 kg.

**114 mm Drop Bracket
Part Number**

MD-IDL19-57-00

Note: BRACKETS ARE PRICED AND SOLD SEPARATELY, TWO BRACKETS ARE REQUIRED PER ROLLER.

STEPHENS-ADAMSON CONVEYING

www.Stephens-Adamson.com

CANADA
Telephone: 1-800-510-3802
Fax: 1-613-967-8128

U.S.A.
Telephone: 1-800-638-6788
Fax: 1-800-866-1438

INTERNATIONAL
Telephone: 1-613-962-3411
Fax: 1-613-967-8128

DS-E-IDL-00-050